

(19)  
(12)

(KR)  
(S)

(52) C6-4330

(45)

1999 07 01

(11)

30-0240480

(24)

1999 04 19

(21)

30-1998-0013293

(22)

1998 08 07

(73)

476

1 803

(72)

476

1 803

(74)

(54)

" "

1.

2.

가

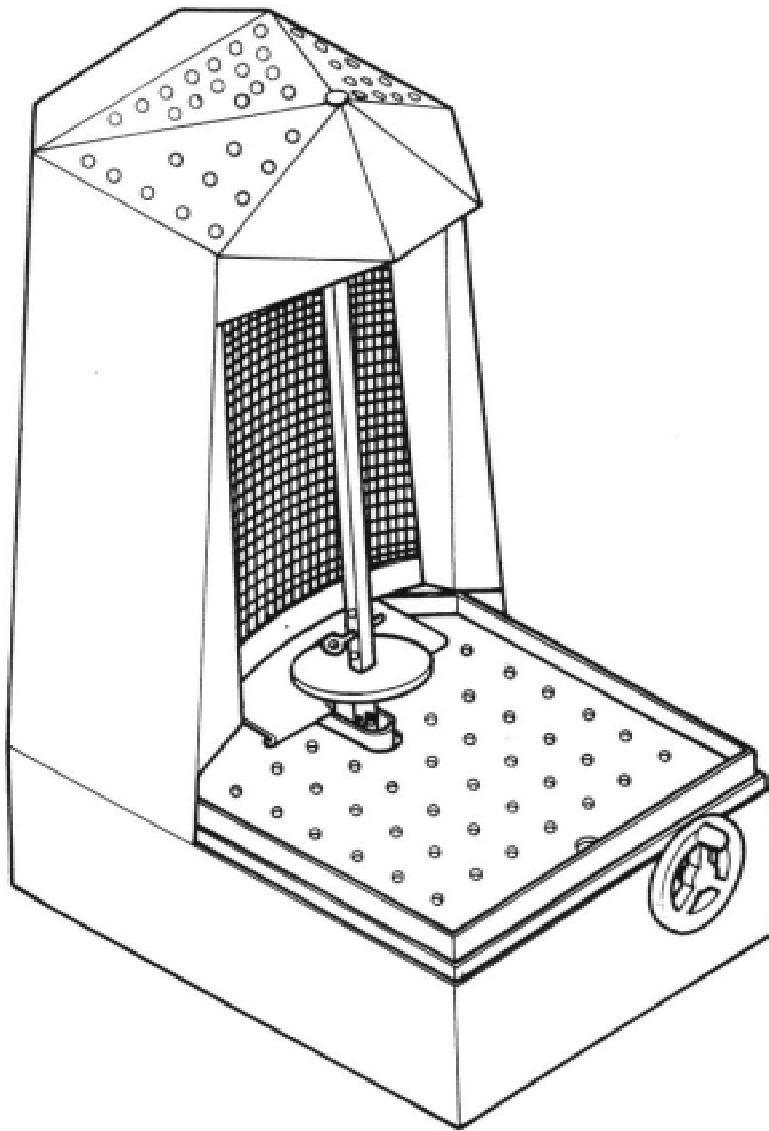

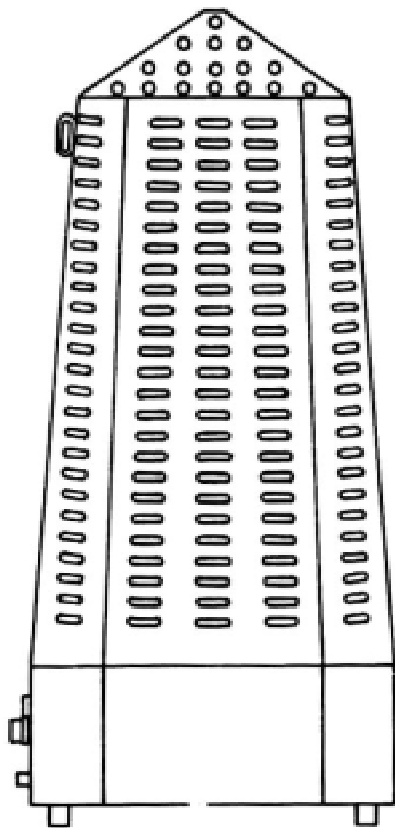
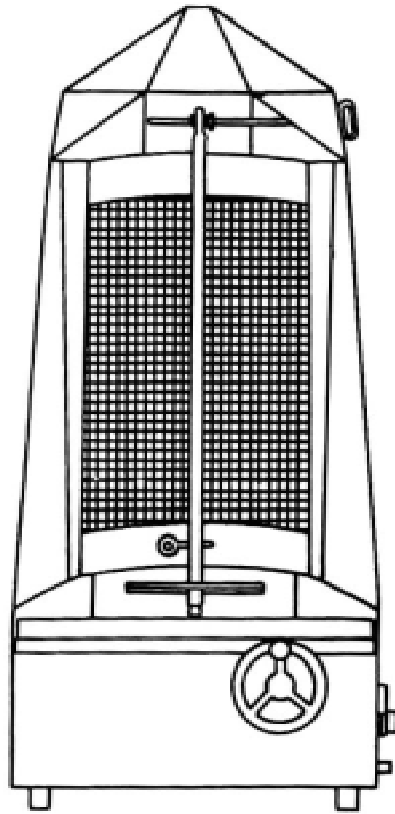

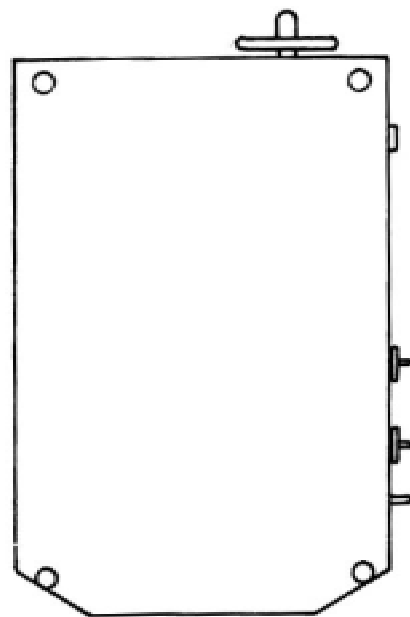
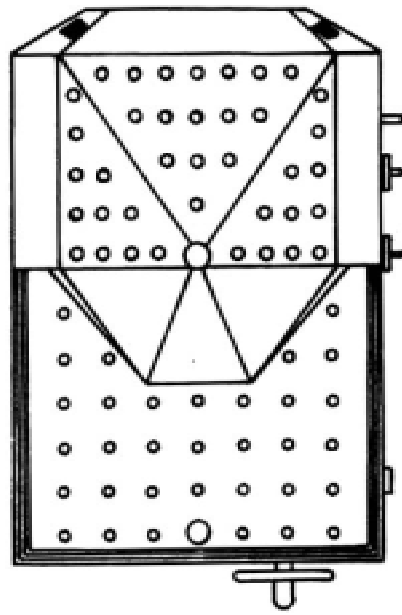

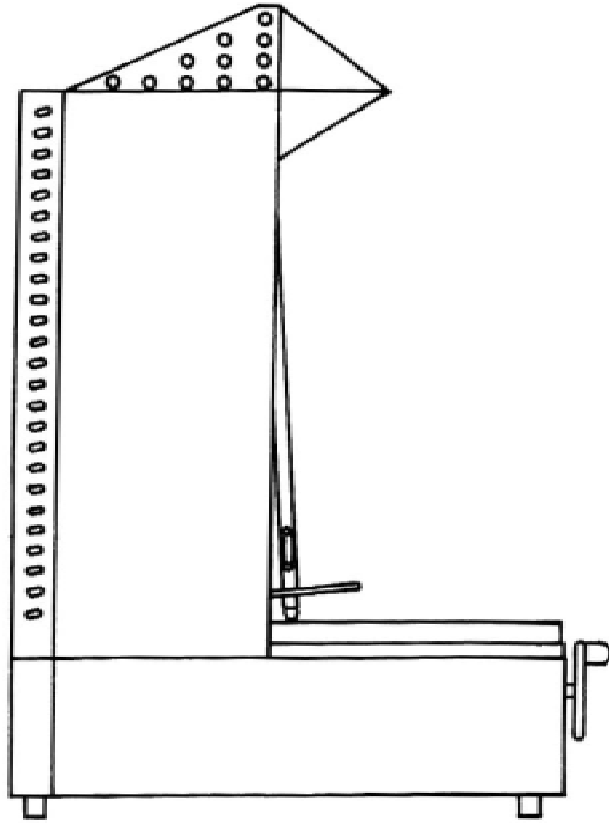

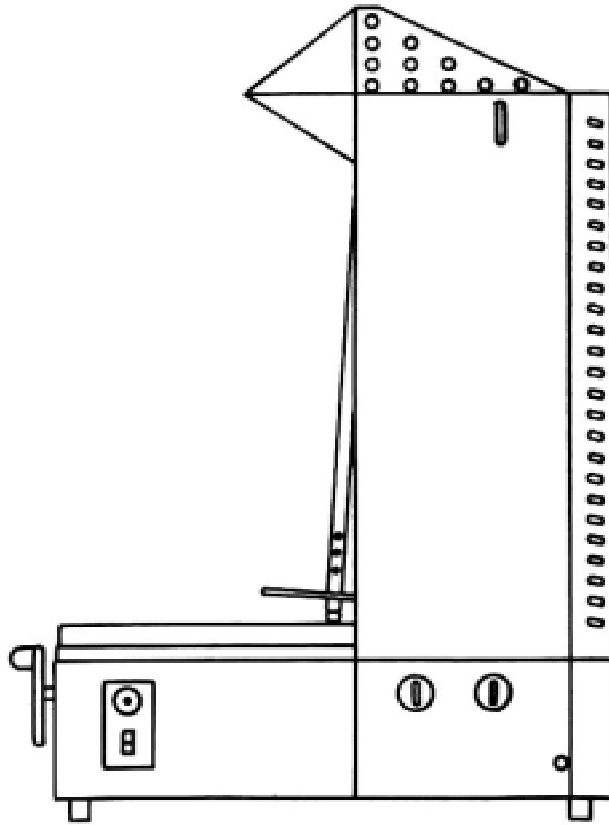

FIG